

LED Down Light – D100_ 4inch 8W

Authorized Licensee for TOSHIBA trademark



1. Specification:

A. General Data

Model	D100_4inch 8W 3000K	D100_4inch 8W 4000K	D100_4inch 8W 6500K
P/N	DELS-DL3400841A051	DELS-DL4400841A051	DELS-DLC400841A051
Westnet Code	00172857	00172858	00172859
Rated Voltage	230 VAC		
Frequency	50 Hz		
Rated Wattage	8 W		
Deviation Tolerance of Wattage	±10 %		
Rated Current	0.06 A		
Maximum Input Current	0.069 A		
Dimmable	Non-Dim		
Beam Angle	110°		
Energy Efficiency Class(EEC)	F		
Peak luminous intensity (cd)	Non-directional		
R9 CRI	1		
Survival factor	0.9		
Safety requirements	CE		
Displacement factor (cos φ1)**	≥0.7		
Stroboscopic effect	0.9		

metric (SVM)	
Flicker metric (PstLM)	1
Ingress protection rating	IP20
Impact resistance	N.A
Photobiological Group	RG 0

* Displacement factor tolerance +/- 10%

B. Light Data

Color	Warm White	Neutral Withe	Cool White
Color Temperature (CCT)	3000K	4000K	6500K
Lumen Output* (ϕ_{Total}°)	750 lm		
Color Rendering Index*	≥ 80		
Efficacy(ϕ_{Total}°)	93.75 lm/W		
Color Consistency**	6 Step MacAdam Ellipse (6 SDCM)		

* tolerance +/- 10%

** 3000K center point (0.43387, 0.40319) ; 4000K center point (0.38177, 0.37959) ; 6500K center point (0.31230, 0.32825)

C. Lifetime

(Supplied Voltage: AC 230V ; Ambient Temperature: 25°C)

Lumen Maintenance Factor	70% of the rated lifetime
Rated Lifetime – L₇₀B₅₀	15,000 hrs
Lumen Maintenance factor	93.1%

D. Temperature Operation

Normal operation temperature	-20°C ~ 40°C
Relative Humidity	10% ~ 90%

E. Geometric Data

Model	LED Down Light D100_4inch 8W
Maximum overall width	115 ± 2 mm
Maximum overall height	34 ± 2 mm
Minimum cut out	95 mm
Mass	67g ± 10%

F. Environmental relevant materials

Mercury (Hg)	Comply with RoHS Directive 2011/65/EU
Lead (Pb)	
Cadmium(Cd)	
Hexavalent Chromium(Cr6+)	
Polybrominated Biphenyls(PBBs)	
Polybrominated Diphenyl Ethers(PBDEs)	
Bis (2-ethylhexyl) phthalate(DEHP)	
Butyl benzyl phthalate(BBP)	
Dibutyl phthalate(DBP)	
Diisobutyl phthalate(DIBP)	

2. Outline Drawing

Unit : mm

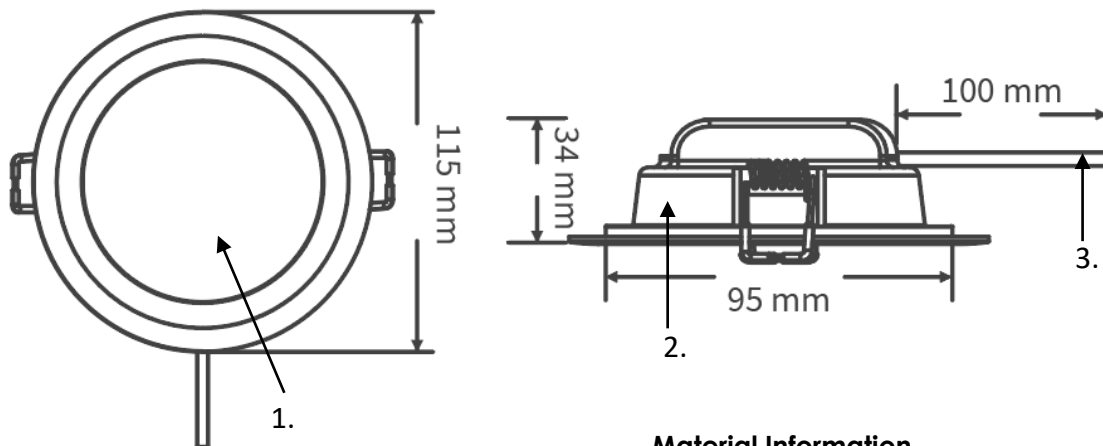

Material Information

1. Cover : PC
2. Plastics enclosed : PPS
3. AC Wire : H03VVH2-F

3. Light Distribution Curve

FWHM 110°

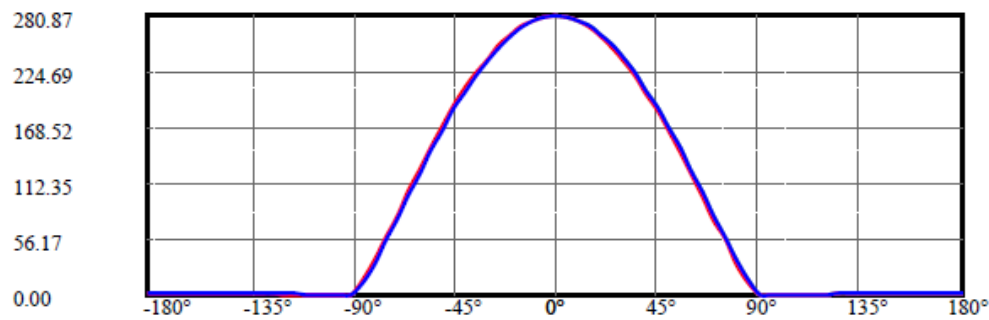
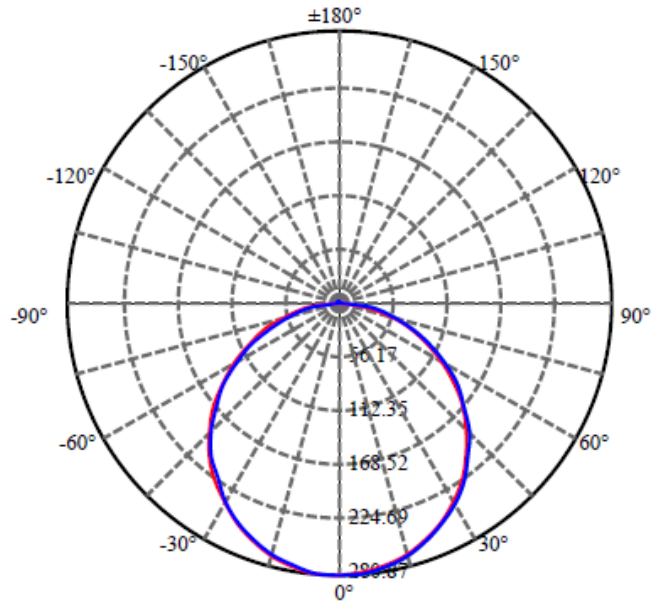

C90(Max): ———

C0/C180: ———

C90/C270: ———

Field angle(10%Imax):C0/180Left:82.0 Right:80.9

:C90/270Left:81.0 Right:81.9

Beam Angle(50%Imax):C0/180Left:56.9 Right:55.7

:C90/270Left:56.1 Right:56.7

4. Spectrum Distribution

3000K Color Temperature

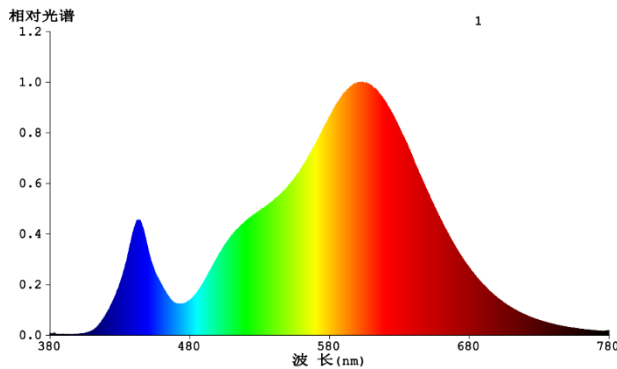

4000K Color Temperature

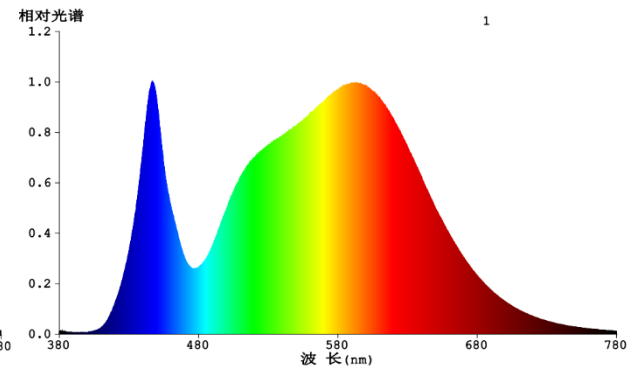

6500K Color Temperature

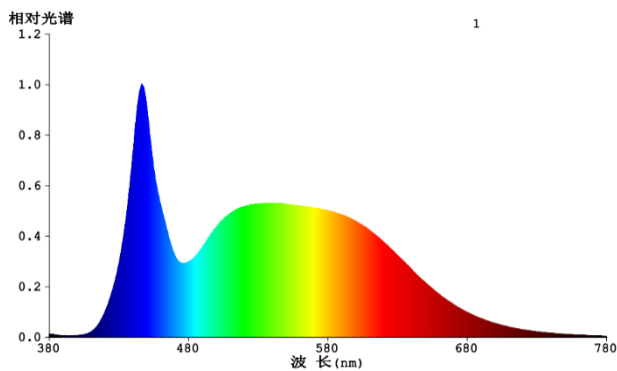

5. Warnings

Before replacing, turn off power and let lamp cool to avoid electrical shock or burn.

6. Cautions

- Not intended for use with emergency light fixtures for exit lights.
- Electrical work and repairs must be performed by qualified electrician.
- During installation, always observe the national installation regulations.
- The luminaire must not be modified in any way. Risk of electric shock and accident.
- The light source contained in this luminaire shall only be replaced by the manufacturer or his service agent or a similar qualified person.
- If the external flexible cable or cord of this luminaire is damaged, it shall be exclusively replaced by the manufacturer or his service agent or a similar qualified person in order to avoid a hazard.
- Do not use outdoors.

7. Notes

All characteristics are estimated at room temperature (25°C), free air burning, base up burning position and at rated voltage. In view of the complex manufacturing process for light above for the technical LED parameters are merely statistical values that do not necessarily correspond to the actual technic individual products may vary from the typical values.

8. Logistic information

Model	LED Down Light D100_4inch 8W 3000K	LED Down Light D100_4inch 8W 4000K	LED Down Light D100_4inch 8W 6500K
Pieces per pack	1	1	1
EAN code on pack	4711112387816	4711112387823	4711112387830
Size of pack	117*40*117 mm		
Weight per pack (G.W)	80g		
Packs per inner box	N/A		
EAN code on inner box	N/A		
ITF code on inner box	N/A		
Size of inner box	N/A		
Weight per inner box(G.W)	N/A		
Packs per outer box	50		
EAN code on outer box	N/A		
ITF code on outer box	14711112387813	14711112387820	14711112387837
Size of outer box	600*246*220 mm		
Weight per outer box(G.W)	5.1kg		

LED Down Light D100_4inch 8W 3000K



LED Down Light D100_4inch 8W 4000K



Packing Photograph

LED Down Light D100_4inch 8W 6500K



9. ERP Label

8W 3000K

8W 4000K

8W 6500K

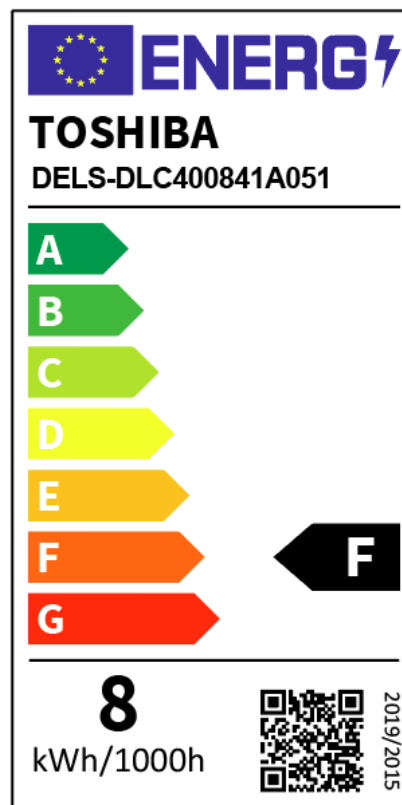
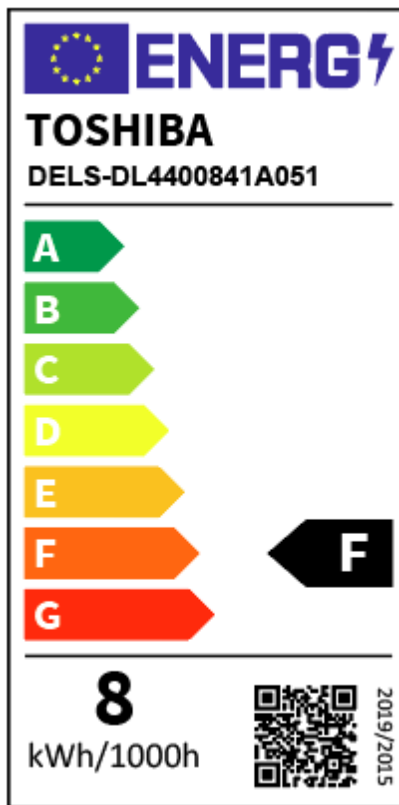
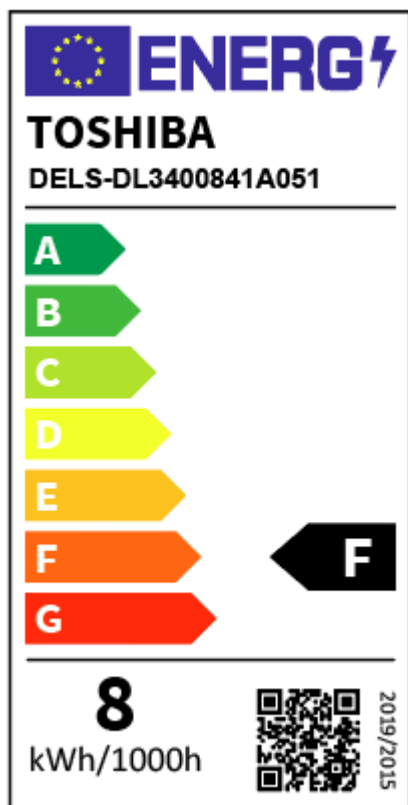

10. Conformity

2014/35/EU; Low Voltage Directive	EN 60598-1:2015 + A1 :2018 · EN 60598-2-2:2012 · EN62493:2015
2014/30/EU; EMC Directive	EN IEC 55015:2019 + A11:2020 · EN IEC 61000-3-2:2019 · EN 61547:2009 EN 61000-3-3:2013 + A1:2019
2009/125/EC; ErP Directive	(EU) 2019/2015 · (EU) 2019/2020 · (EU)2021/340 · (EU)2021/341
2011/65/EU+(EU)2015/863; RoHS Directive	EN 50581: 2012