

# Profil LED WIDE

- 1 - profil LED WIDE
- 2 - ta ma LED
- 3 - klosz WI mleczna/szron
- 4 - za lepka WI
- 5 - osłona WI
- 6 - za lepka WI-O
- 7 - przewód

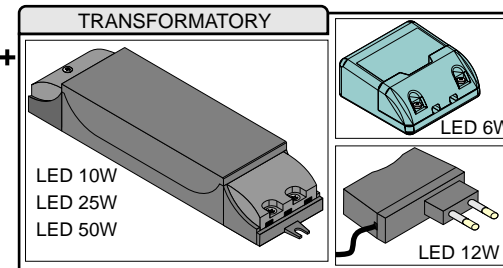
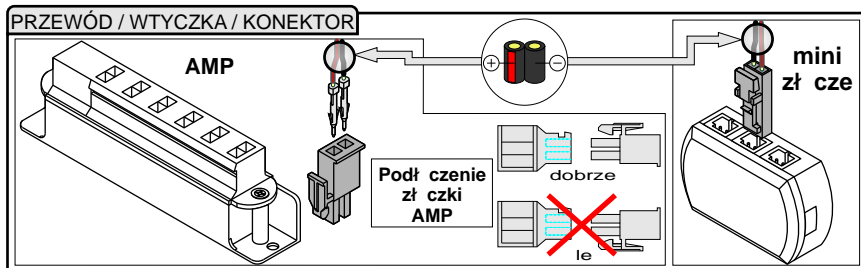
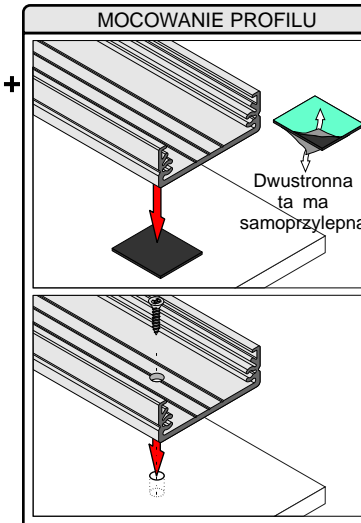
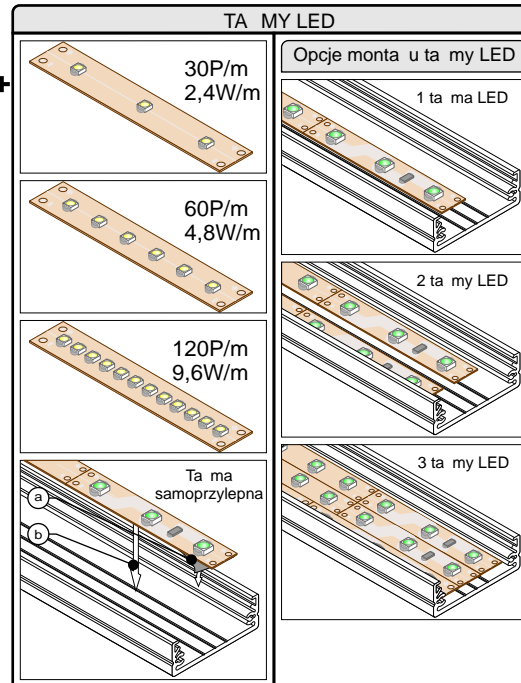
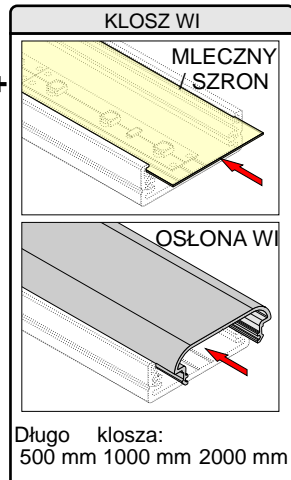
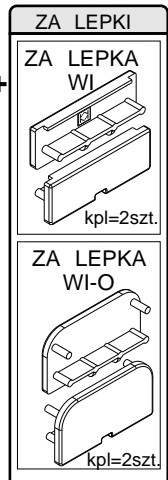
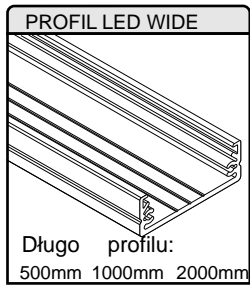
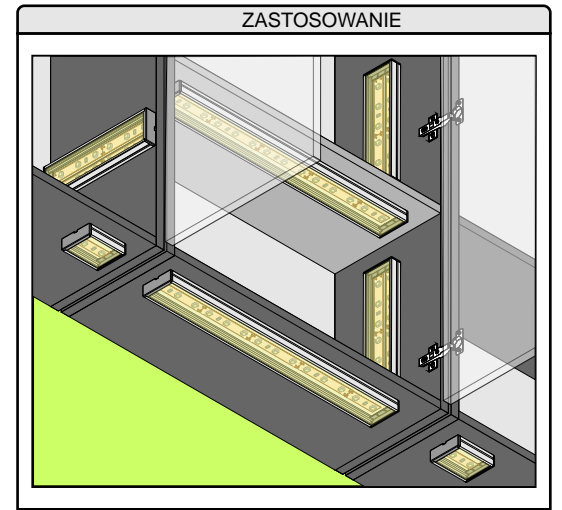
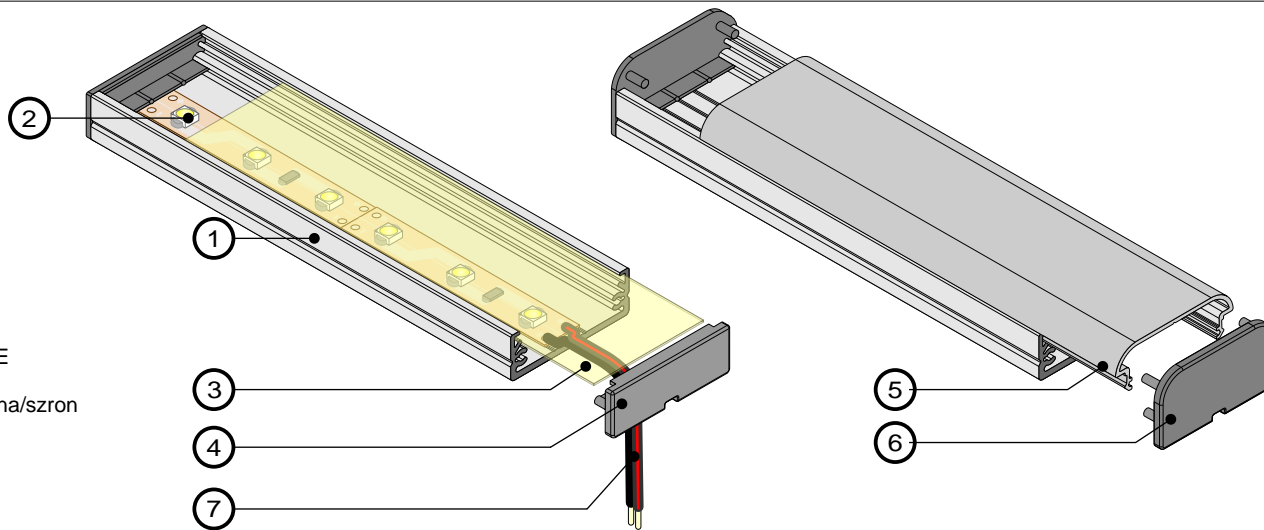

instrukcja pod adresem: [www.topmet.pl](http://www.topmet.pl) w zakładce DO POBRANIA/INSTRUKCJE