



InfraRed Industrial Heat Incandescent

PAR38 IR 100W E27 230V CL 1CT/12

The Philips infrared incandescent reflector lamps are designed to work in the toughest environment such as farm, bathroom or kitchen and their nearest surrounding. They have a reinforced construction thanks to hard glass use. Their compact form and universal cap base allow them to be used with any suitable equipment. A very good method of generating warmth is by using heat lamps. The Philips infrared lamps provide direct, draught-free warmth to the animals, but also food. These benefits have made farmers and cooks around the world choose Philips infrared lamps, because they are the sturdiest, most efficient lamps available for these applications.

Product data

General information	
Cap-Base	E27 [E27]
Operating Position	UNIVERSAL [Any or Universal (U)]
Main Application	Infrared Industrial
Nominal Lifetime (Nom)	5000 h
Rated Lifetime (Hours)	5000 h
Light technical	
Color Designation	C
Operating and electrical	
Power (Nom)	100 W
Voltage (Nom)	230 V

Controls and dimming	
Dimmable	Yes
Mechanical and housing	
Bulb Finish	Clear
Bulb Material	Hard Glass
Bulb Shape	PAR38 [PAR 4.75 inch/121mm]

Product data	
Full product code	871150011578215
Order product name	PAR38 IR 100W E27 230V CL 1CT/12
EAN/UPC - Product	8711500115782
Order code	923801244209
Numerator - Quantity Per Pack	1
Numerator - Packs per outer box	12
Material Nr. (12NC)	923801244209

InfraRed Industrial Heat Incandescent

Net Weight (Piece) 308.000 g

Dimensional drawing

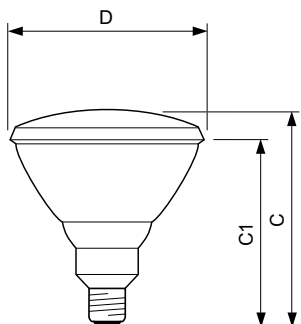

PAR38 IR 100W E27 230V CL 1CT/12

Product	D	C (max)	C1 (max)
PAR38 IR 100W E27 230V CL 1CT/12	121 mm	136 mm	124 mm

