

## KCP

### Stycznik mocy KCP



KCP-09-230

	Kategoria użytkowania	Napięcie zasilania cewki [V]	Styki główne	Styki pomocnicze	Ilość styków zwiernych/rozwiernych
KCP-09-230	<b>24100</b>	AC-3	230 AC	3	1
KCP-09-24	<b>24101</b>	AC-3	24 AC	3	1
KCP-12-230	<b>24102</b>	AC-3	230 AC	3	1
KCP-12-24	<b>24103</b>	AC-3	24 AC	3	1
KCP-18-230	<b>24104</b>	AC-3	230 AC	3	1
KCP-18-24	<b>24105</b>	AC-3	24 AC	3	1
KCP-25-230	<b>24106</b>	AC-3	230 AC	3	1
KCP-25-24	<b>24107</b>	AC-3	24 AC	3	1
KCP-32-230	<b>24108</b>	AC-3	230 AC	3	1
KCP-32-24	<b>24109</b>	AC-3	24 AC	3	1
KCP-AX11	<b>24110</b>	AC-15		2	1/1
KCP-AX22	<b>24111</b>	AC-15		4	2/2

Styczniki mocy przeznaczone są do łączenia obwodów prądu przemiennego w klasie użytkowania AC3. Zakres prądowy oferty do 32A, napięcie zasilania 24VAC lub 230VAC. Styczniki standardowo posiadają styk pomocniczy 1NO.

## KCP

### Stycznik mocy KCP



KCP-09-230



KCP-09-24



KCP-12-230



KCP-12-24



KCP-18-230



KCP-18-24



KCP-25-230



KCP-25-24



KCP-32-230



KCP-32-24



KCP-AX11



KCP-AX22

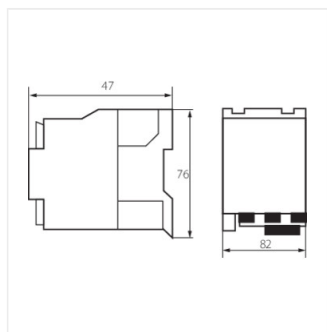

KCP-09-230

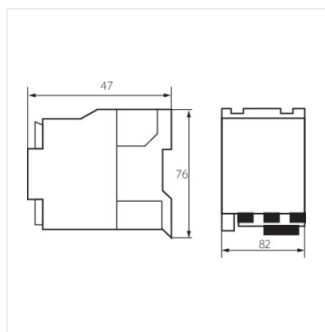

KCP-09-24

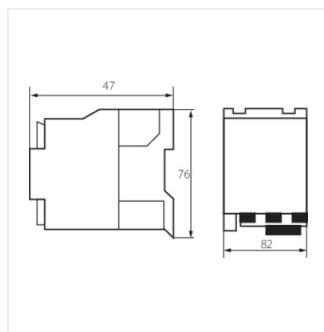

KCP-12-230

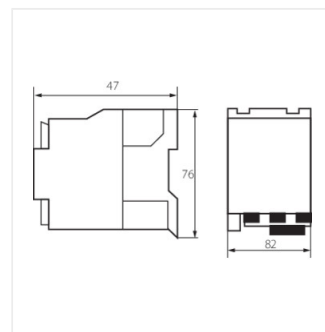

KCP-12-24

## KCP

### Stycznik mocy KCP

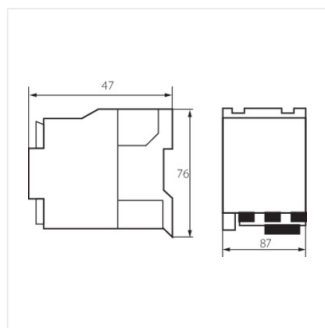

KCP-18-230

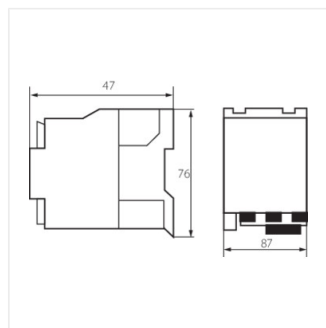

KCP-18-24

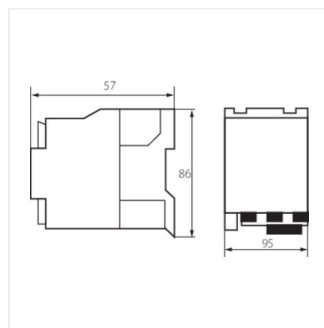

KCP-25-230

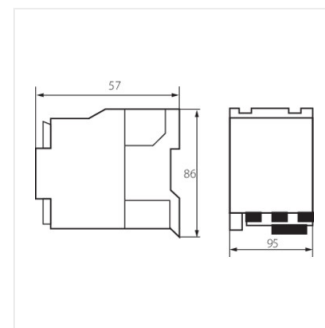

KCP-25-24

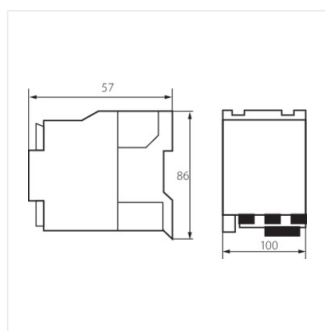

KCP-32-230

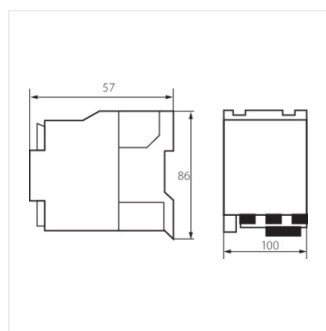

KCP-32-24

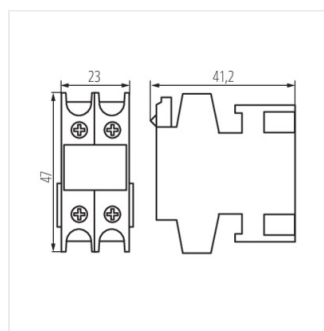

KCP-AX11

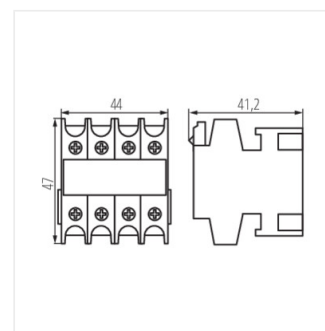

KCP-AX22